



# BIOFIL

**Controlling the bacteriological quality of water**  
Filter the bacteria at the mixer/tap outlet  
Designed for Healthcare Facilities  
And other Public Buildings

- ▶ Cartridge filters
- ▶ Shower head filters
- ▶ Spout filters



**DELABIE**  
delabie.com

## ▶ Controlling waterborne health risks

The prevention of health risks associated with pathogenic bacteria in water systems should be a constant concern for buildings open to the public and in particular Healthcare Facilities.

Water, essential for hygiene, can also be a source of infection if the quality is not controlled. The proliferation of bacteria (*Legionella*, *Pseudomonas aeruginosa*, etc.) in the water supply or in mixers and taps may cause serious infections, especially for vulnerable people.

Control of this health risk is a major and ongoing concern for those responsible for buildings.

Water systems in all buildings open to the public should be monitored for *Legionella* (e.g. hotels and holiday accommodation, campsites, prisons, etc.) and not just Healthcare Facilities. The HSE Approved Code of Practice and Guidance (ACOP) document L8 states that the risk of exposure to *Legionella* should be prevented or controlled and that the precautions taken should be monitored to ensure that they remain effective. This applies in all circumstances where the Health and Safety at Work Act 1974 applies.

*Legionella* bacteria occur naturally in the environment and *Legionella pneumophila* may become a risk if found in any point-of-use which can create an aerosol (a spray of tiny water droplets in the air).

Our BIOFIL filters are a means to ensure the quality of water at the point-of-use to protect the health of the user.



## ▶ BIOFIL Range water filters

**A collection of single use water filters: BIOFIL cartridges, shower heads and spouts.**

Each BIOFIL incorporates a hollow fibre membrane with a **water filtration threshold of 0.1 micron absolute-rated**. They deliver water free from microorganisms (bacteria, protozoa, fungi, particles in water systems, etc.), without changing its chemical composition.

### ▶ Total protection against waterborne infection.

## ▶ Innovative technical solution: hollow fibre microfiltration

There are two main types of membrane used in terminal microfiltration devices: flat membrane or hollow fibre membrane.

### ▶ DELABIE uses the latest technology for its range of BIOFIL micro-filters: filtration via hollow fibre membrane.

This membrane technology, developed in the 1970s, is now recognised as the most effective water purification process.

It covers applications up to ultra filtration (0.001 micron) in numerous environments (home, medical, industrial, etc.).

## ► How our hollow fibre filtration works

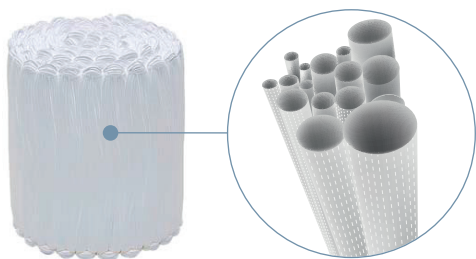

### Hollow fibre membrane

Our filter is made up of a collection of polyethylene hollow fibres grouped together into a unit. The fibres are extremely fine and flexible, with an outer diameter of 0.6 mm and a thickness of several tens of microns.

► **The membranes are hollow and shaped like a straw (tube).**

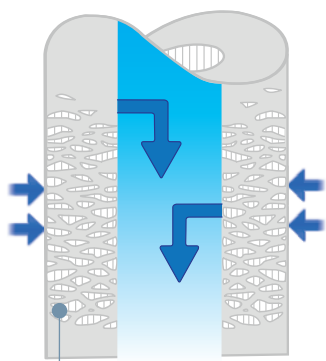

Porosity  $\leq 0.1$  micron

### Micro-porous structure

The hollow fibre membranes have multiple pores which vary in size from 0.01 – 0.1 micron.

Each membrane consists of several surfaces with micro-porous structures (micro slits).

► **Bacteria and any particles in suspension that are larger than 0.1 micron are trapped by these structures and retained on the external surface of the membrane.**

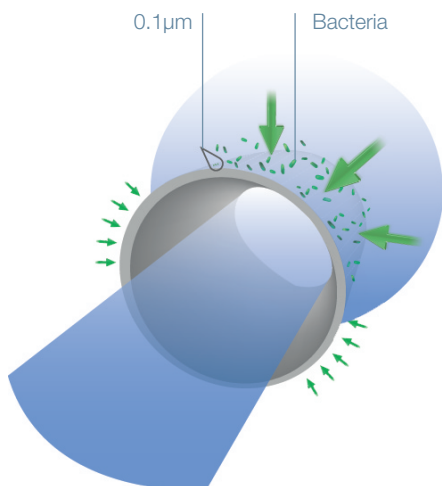

### External/Internal frontal filtration

We use a frontal filtration system. The water flow is perpendicular (at right angles) to the filter surface and passes through the membrane due to the pressure difference on either side of the membrane.

► **The water flows from the outside to the inside surface of the fibre.**

Bacteria and other micro particles that cannot pass through the gaps in the membrane structure are retained on the outer surface and therefore do not penetrate the membrane.

### Filtration surface / storage of bacteria

The filtration area is significantly higher on our hollow fibre membranes than for flat membranes (1,400cm<sup>2</sup> versus approximately 500 cm<sup>2</sup>).

► **This large filter area means that it is possible to filter a larger volume of water.**

Therefore the storage capacity for bacteria and impurities trapped inside the filter is also much greater.

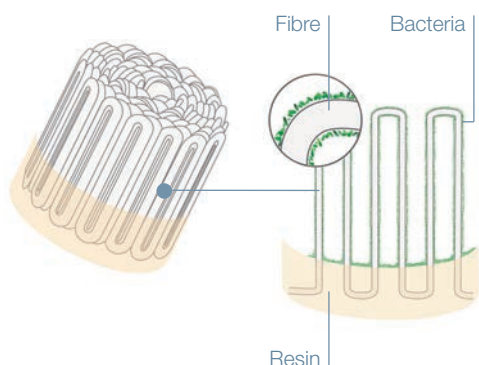

## Product advantages



- + Filtration surface is twice the size** of a flat membrane (1400 cm<sup>2</sup> versus approximately 500 cm<sup>2</sup>)
  - ▶ Filters a larger volume of water
  - ▶ **Fibre 0.1 micron absolute-rated:** maximum pore size conforming to current standards
- + Resistance to clogging**
  - ▶ Particles in suspension remain on the surface of the membrane which slows the clogging of the filter
  - ▶ Increases the lifespan of the membrane
- + Compact filters**
  - Unlike other terminal filters on the market, our BIOFIL filters are smaller due to the **compact nature of the fibre:**
    - ▶ Suitable for all mixers/taps, even those with a low outlet height
    - ▶ Prevents auto-detection when installed on a electronic taps
    - ▶ Less risk of retro-contamination
    - ▶ Increased outlet height compared to other filters on the market
- + Spout filter: exclusive**
  - Spout incorporating a hollow fibre membrane:
    - ▶ Suitable for all mixers/taps with BIOCLIP spouts (without connector)
    - ▶ No additional space required (outlet height maintained)
    - ▶ No devices added to the end of the spout
    - ▶ The spout is no longer a potential source of contamination

## Complete control of the manufacturing process

Our hollow fibre membrane is made from 100% recyclable polyethylene (PE) fibres. No additives or solvents are used during the manufacturing process.

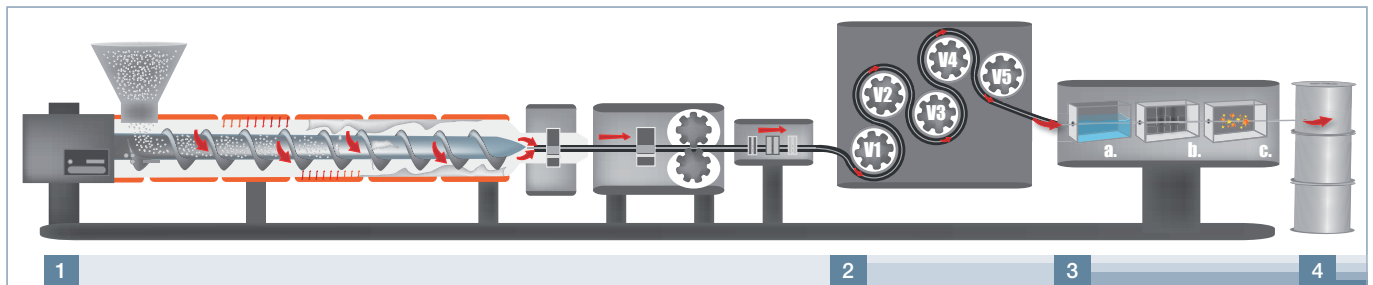

### 1 The raw material is extruded

The raw material (PE) is fed into the extruder in the form of beads which are tipped into the hopper which in turn feeds the extruder screw. It is then heated and softened to make it malleable as it travels along the screw, which is located in a heated cylinder. The plastic travels along the screw towards the extruder outlet which gives the material the desired tubular shape.

### 2 The material is stretched

The fibre comes out in a continuous thread which is then stretched 5 times passing around rollers set at different speeds. This process determines the porosity of the fibres. The greater the difference in speed, the higher the porosity and vice versa. Our fibres have a porosity of **0.1 micron**. The manufacturing process can be used to achieve a porosity of 0.01 micron.

### 3 Testing Phase (3 stages)

#### a. The fibre passes through water under pressure.

At a certain water pressure for 0.1 micron of porosity, water does not penetrate into the fibre. If the porosity is not correct, water enters the fibre.

#### b. The fibre exterior is dried.

#### c. The fibre passes through an electrical field.

If water has entered the fibre an electric arc is created which immediately burns the fibre and cuts it. This Testing Phase is carried out continuously.

### 4 Winding onto Reels

If the fibre passes the Test Phase, it is then wound onto reels for assembly.

**Controlling the porosity of the fibre.  
The fibre is 100% tested.**

## ► Areas of use



### LEGIONELLA and PSEUDOMONAS AERUGINOSA filters

These non-sterile BIOFIL filters are suitable for public buildings, particularly Healthcare Facilities (in areas that do not require filters for All Germs) for:

- personal bathing
- hygienic hand washing
- balneotherapy

### ALL GERMS filters

These sterile BIOFIL filters are classified as Medical Device Class IIB, and are recommended in healthcare facilities for:

- washing wounds
- rinsing invasive medical devices (e.g. endoscopes)

## ► Complete traceability for BIOFIL

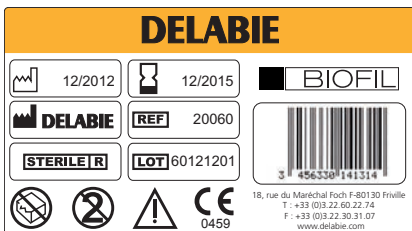

Controlling waterborne health risks requires complete traceability from component manufacture through to the final use of the product by the patient.

### Each individual packet is labelled

The unique batch number can easily be traced back throughout the production process.



### Double labelling on the filter

Each filter is supplied with 2 waterproof labels identifying the product and ensuring traceability when the filter is changed.

#### ► Label 1 is removable and can be transferred to the record log to ensure traceability

- Filter reference
- Dates for start and end of service to be entered manually
- Batch number
- Barcode

#### ► Label 2 remains on the filter

- Dates for start and end of service to be entered manually
- Batch number to be entered manually

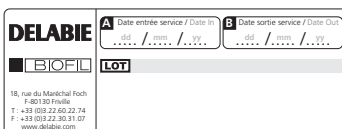

## ► BIOFIL filter performance

5

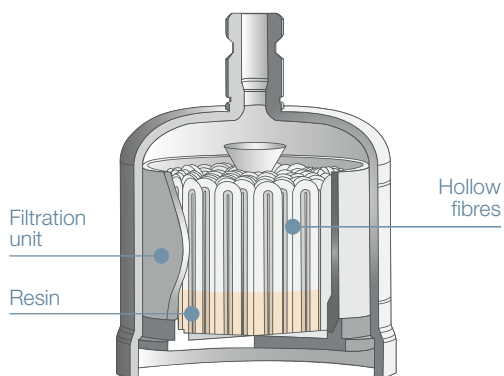
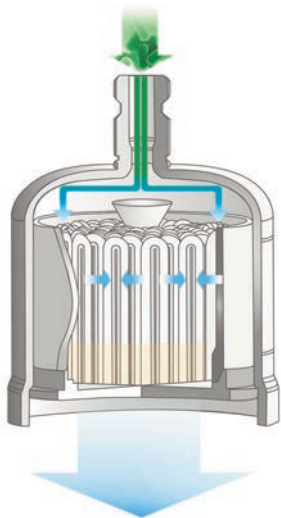

## Bacterial Challenge

### ► Bacterial retention test conforming to ASTM F838-05\*

The SGS laboratory, the world's leading organisation for inspection, verification and certification, submitted our BIOFIL filters to this bacterial challenge. It confirms the effective bacterial retention power of the filters used for the decontamination of liquids.

This test involves passing a dose of *Brevundimonas diminuta* bacteria (ATCC 19146) through the filter, which is the smallest bacterial species, at a minimum concentration of  $10^7$  UFC/ cm<sup>2</sup> on the filtration surface.

A filter is designated a decontaminant if no colonies are counted in filtered water.

When subjected to this test, all our BIOFIL filters delivered an effluent free of bacteria, so they have a sterilising grade of 0.1 micron.

\* Standard Test Method for Determining Retention of Membrane Filters Utilized for Liquid Filtration.

BIOFIL Product	No. of colonies/surface upstream (CFU/cm <sup>2</sup> )	<i>Brevundimonas diminuta</i> bacterial challenge downstream (CFU)**	No. of bacteria at the filter outlet
Cartridge	$6.58 \times 10^7$	$9.212 \times 10^{10}$	0
Shower head	$6.58 \times 10^7$	$9.212 \times 10^{10}$	0
Spout	$7.67 \times 10^7$	$9.212 \times 10^{10}$	0

\*\* 1.4 litres of water at 6.58 CFU 10<sup>7</sup>/cm<sup>2</sup> were passed through the filter and downstream of the filter there were no bacteria.

## Average flow rate for different water pressures

BIOFIL Product	1 bar	2 bar	3 bar	4 bar	5 bar
Cartridge	3 l./min.	7.2 l./min.	9.6 l./min.	12 l./min.	13.2 l./min.
Shower head	4.8 l./min.	10.2 l./min.	14.4 l./min.	17.4 l./min.	20.4 l./min.
Spout	3 l./min.	6 l./min.	9.6 l./min.	11.4 l./min.	12 l./min.

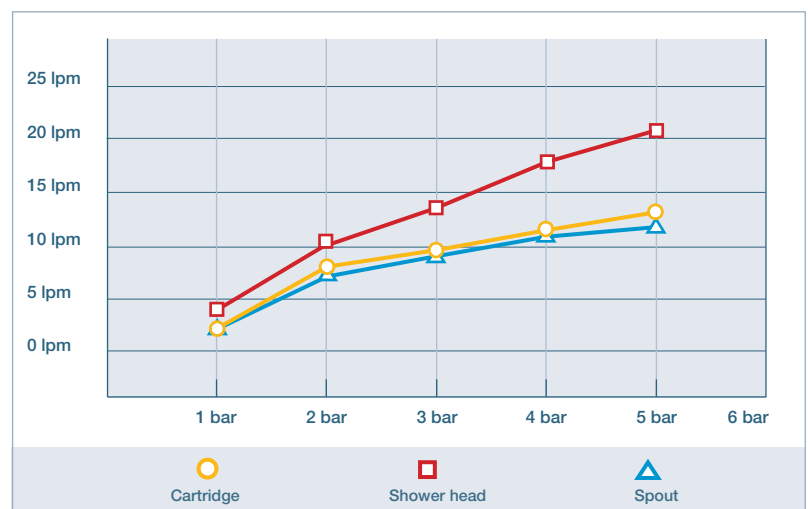

Water filtered to 0.1 micron to remove all particles  $\geq 0.1 \mu\text{m}$ .  
Maximum upstream pressure: 5 bar.

## ► Lifespan

### Durability of our BIOFIL filters

#### Maximum period of use

##### ► Legionella and Pseudomonas aeruginosa filters

These filters can be used for up to 62 days after initial installation.

##### ► All Germs filters

These sterile filters, typically used in more sensitive areas, have a lifespan of 31 days after initial installation.

After these periods, we recommend changing the filter to avoid any risk of retro-contamination from the bacteria concentrated in the filter.

**Note:** The amount of impurities in the water will vary between water systems. Filters will therefore become clogged at different rates. If the filter becomes clogged before the provisional replacement date of the filter, it should be changed. If clogging is an issue, we recommend pre-filtering the water upstream at different levels of the system to prevent excessive amounts of sand and scale. There is much less bacterial growth in an installation where the water is pre-filtered and the lifespan of all equipment is greatly increased.

Intermittent use does not extend the life of the filter.

The filters can be used continuously or for a specific period of time to manage a contamination episode.

#### Compatibility with and resistance to different curative treatments

Our BIOFIL filters will withstand the frequent thermal and chemical shocks that are often undertaken in public buildings, especially Healthcare Facilities.

##### ► Resistance to thermal shocks:

Temperatures of 70°C for a cumulative period of 30 minutes during its lifetime.

Any impurities that are dislodged during a thermal shock are trapped in the filter and will reduce the lifespan of the filter. We recommend changing the filter after a thermal shock.

##### ► Resistance to chemical shocks:

Free chlorine levels up to 3 ppm, at 20°C +/- 5°C over its entire life and/ or up to 100 ppm at 20°C +/- 5°C for 1 hour.

## ► Other features



#### Sterilisation complies with European standard EN ISO 11137

BIOFIL All Germs filters (medical devices) are sterile when delivered. After manufacture they are sterilised using gamma rays.

Each individual packet has a **visual marker** showing that it has been **sterilised**.

-After gamma sterilisation BIOFIL filters have a shelf life of 3 years. The product expiry date is marked on each individual packet.

- BIOFIL sterilised filters conform to European Directive 93/42/EEC Medical Devices Amendment 2007/47/EC and are CE marked. 

#### Certification ISO 9001: 2008

## ► Quick and easy to install

7



### Cartridge/Shower head filters

- Our filters are simple to connect to the outlet requiring treatment without the need for tools: **Push-fit connectors** can be fitted to all mixer/tap outlets or flexible shower hoses.
- No need to shut-off the water supply.

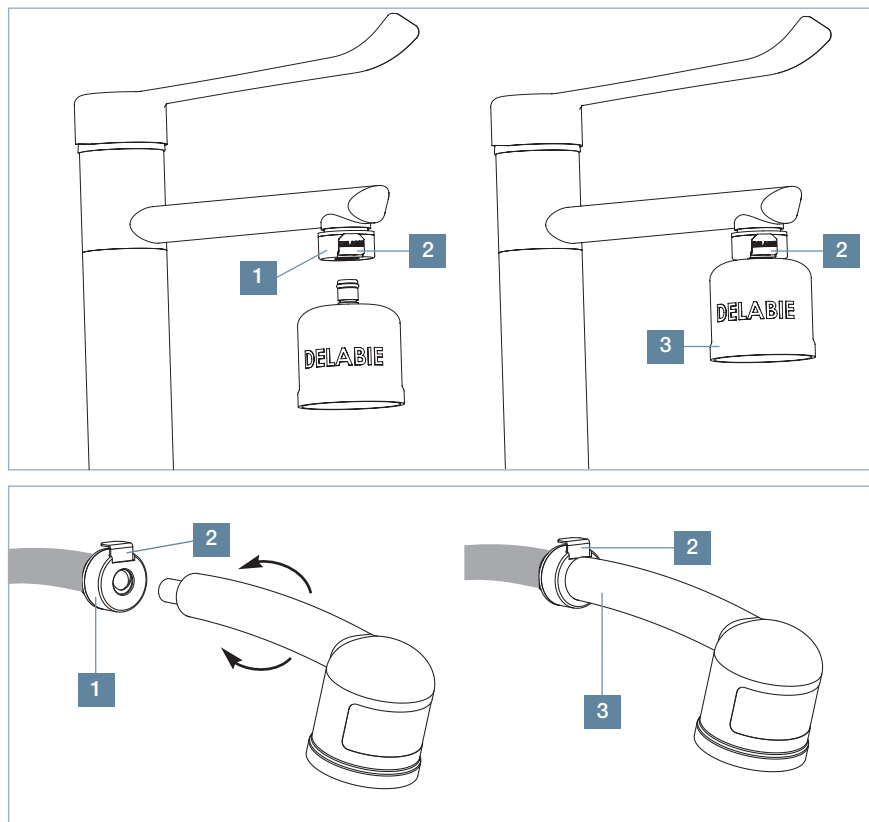

To connect the cartridge or shower head using the connector, **1** press on the tab **2** and then insert the cartridge or shower head **3**. Release the tab **2**.

### Spout filter

**Only suitable for BIOCLIP mixers and taps.**

- Remove the BIOCLIP spout and insert the BIOFIL spout in its place.
- No need to shut-off the water supply.

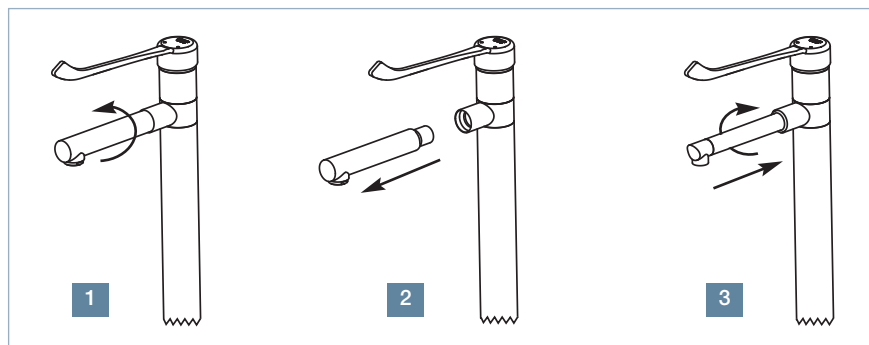

## ► Available for immediate use after installation

Once the filter is in place the mixer or shower can be used immediately.



## ► BIOFIL Cartridge

### BIOFIL Cartridge with single use filter



20050A  
30050A

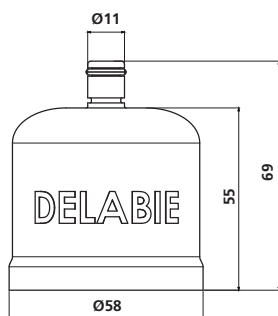

20050P  
30050P

**Single use BIOFIL cartridge, sterilising grade 0.1 micron absolute-rated. Immediate protection against waterborne nosocomial infections.**

- Hydrophilic polyethylene membrane with hollow fibres, sterilising grade 0.1 micron.
- Filtration area: 1,400cm<sup>2</sup>.
- Filtration flow rate: 6 lpm\* at 3 bar at the shower/mixer outlet (filter only, no restriction to the flow rate in the mixer).
- Maximum upstream pressure at point-of-use: 5 bar.
- Compatibility with and resistance to different curative treatments:
  - **Thermal shocks:** temperatures of 70°C for a cumulative period of 30 minutes during its lifetime.
  - **Chemical shocks:** Free chlorine levels up to 3 ppm, at 20°C ± 5°C over its entire life and/ or up to 100 ppm at 20°C ± 5°C for 1 hour.
- Polyethylene fibres, filtration unit and cartridge body made from fully recyclable ABS.

\* Average flow rate during the product lifespan

#### 10 sterile cartridge filters, All Germs 0459

Use for up to 31 days after installation.  
Individually wrapped, sterile (marked sterilised).

without O ring seal (cartridge A)	20050A
with O ring seal (cartridge P)	20050P

#### 10 cartridge filters, Legionella and Pseudomonas aeruginosa

Use for up to 62 days after installation.  
Individually wrapped, non-sterile.

without O ring seal (cartridge A)	30050A
with O ring seal (cartridge P)	30050P

► **Option:** Push-fit connector for the mixer/tap outlet (see below).

### Push-fit connectors for all types of mixers and taps



Cartridge filters should be installed using push-fit connectors.  
Quick and easy to install (see opposite).

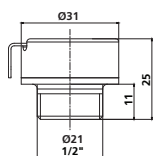

820023

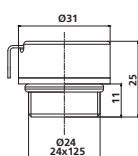

820025

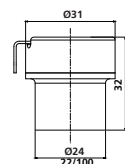

820022/820122

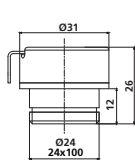

820024/820124

#### Connectors for Cartridge A Ref. 20050A/30050A

Cartridge A does not have an O ring seal on the push-fit connection

Outlet type	F22/100	M24/100	M1/2"	M24/125
Reference	820022	820024	820023	820025

#### Connectors for Cartridge P Ref. 20050P/30050P

Cartridge P has an O ring seal on the push-fit connection

Outlet type	F22/100	M24/100
Reference	820122	820124

## ► BIOFIL Shower Head

9

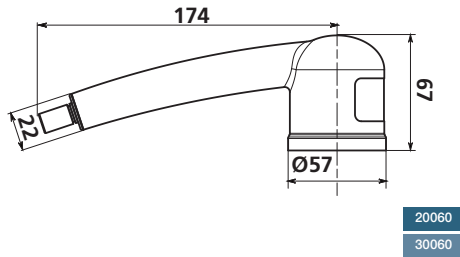

### BIOFIL shower head with integrated filter



**Single use shower head, sterilising grade 0.1 micron absolute-rated. Immediate protection against waterborne nosocomial infections.**

- Hydrophilic polyethylene membrane with hollow fibres, sterilising grade 0.1 micron.
- Filtration area: 1,400 cm<sup>2</sup>.
- Filtration flow rate: 12 lpm\* at 3 bar at the shower outlet (filter only, no restriction to the flow rate in the mixer).
- Maximum upstream pressure at point-of-use: 5 bar.
- Compatibility with and resistance to different curative treatments:
  - **Thermal shocks:** temperatures of 70°C for a cumulative period of 30 minutes during its lifetime.
  - **Chemical shocks:** Free chlorine levels up to 3 ppm, at 20°C ± 5°C over its entire life and/ or up to 100 ppm at 20°C ± 5°C for 1 hour.
- Polyethylene fibres, filtration unit and shower head made from fully recyclable ABS.

\* Average flow rate during the product lifespan

#### 10 sterile shower head filters, All Germs

Use for up to 31 days after installation.  
Individually wrapped, sterile (marked sterilised).

without O ring seal on the push-fit connector	20060
--	-------

#### 10 cartridge filters, Legionella and Pseudomonas aeruginosa

Use for up to 62 days after installation.  
Individually wrapped, non-sterile.

without O ring seal on the push-fit connector	30060
--	-------

► **Option:** Push-fit connector for the outlet (see below).

### Push-fit connectors for all types of mixers

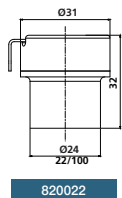

820022

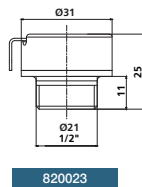

820023

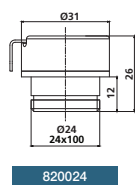

820024

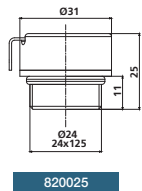

820025



820023



820024



820025

Shower head filters should be installed using push-fit connectors.

- Simple to connect without the need for tools.
- No need to shut-off the water supply.

#### Connectors for Shower heads Ref. 20060/30060

The shower head does not have an O ring seal.

Outlet type	F22/100	M24/100	M1/2"	M24/125
Reference	820022	820024	820023	820025

BIOFIL spout with integrated filter



**+** EXCLUSIVE

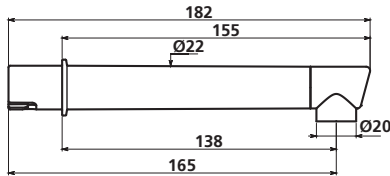

20040  
30040

Single use spout, sterilising grade 0.1 micron absolute-rated.  
Can be installed instead of BIOCLIP spouts.  
Immediate protection against waterborne nosocomial infections.

- Hydrophilic polyethylene membrane with hollow fibres, sterilising grade 0.1 micron absolute-rated.
- Filtration area: 1,200cm<sup>2</sup>.
- Filtration flow rate: 6 lpm\* at 3 bar with star-shaped flow straightener (filter only, no restriction to the flow rate in the mixer/tap).
- Maximum upstream pressure at point-of-use: 5 bar.
- Compatibility with and resistance to different curative treatments:
  - **Thermal shocks:** temperatures of 70°C for a cumulative period of 30 minutes during its lifetime.
  - **Chemical shocks:** Free chlorine levels up to 3 ppm, at 20°C ± 5°C over its entire life and/or up to 100 ppm at 20°C ± 5°C for 1 hour.
- Polyethylene fibres, spout made from fully recyclable ABS.

\* Average flow rate during the product lifespan

<b>10 sterile spout filters, All Germs</b> <small>CE 0459</small>	<b>20040</b>
Use for up to 31 days after installation. Individually wrapped, sterile (marked sterilised).	
<b>10 spout filters Legionella and Pseudomonas aeruginosa</b>	<b>30040</b>
Use for up to 62 days after installation. Individually wrapped, non-sterile.	

# DELABIE, European leader in water controls and sanitary equipment for public buildings



DELABIE includes in its wide product offering BIOSAFE solutions to control the proliferation of bacteria in water controls:

- ▶ Water controls containing low volumes of water
- ▶ Water controls with smooth interiors
- ▶ Removable mixers and taps

And to filter bacteria at the mixer/tap outlet:

- ▶ BIOFIL cartridge, spout and shower head filters

## ▶ Export Sales Team

Tel. +33 (0)3 22 60 22 72  
 Fax. +33 (0)3 22 60 22 82  
 Email: [export@delabie.fr](mailto:export@delabie.fr)

## ▶ Your contact

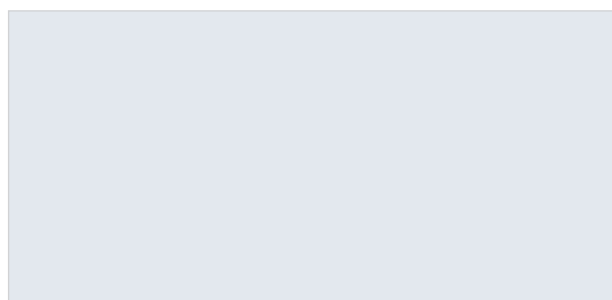

## ▶ Export Technical Support

Tel. +33 (0)3 22 60 22 74  
 Fax. +33 (0)3 22 30 31 07  
 Email: [sav@delabie.fr](mailto:sav@delabie.fr)

## ▶ Export Market available catalogues

- **DOC 900INT:** Water Controls and Terminal Filters for Hospitals
- **DOC 609INT:** Commercial Water Controls
- **DOC 950INT:** Accessibility - Accessories for Public Places
- **DOC 200INT:** Water Controls for Professional Catering

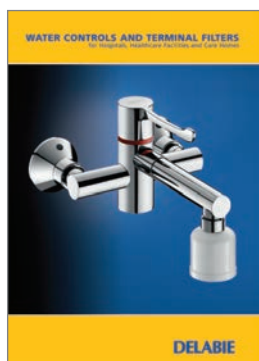

# DELABIE

DELABIE S.C.S. 18, rue du Maréchal Foch 80130 Friville, France Tel. +33 (0)3 22 60 22 72 [www.delabie.com](http://www.delabie.com)